

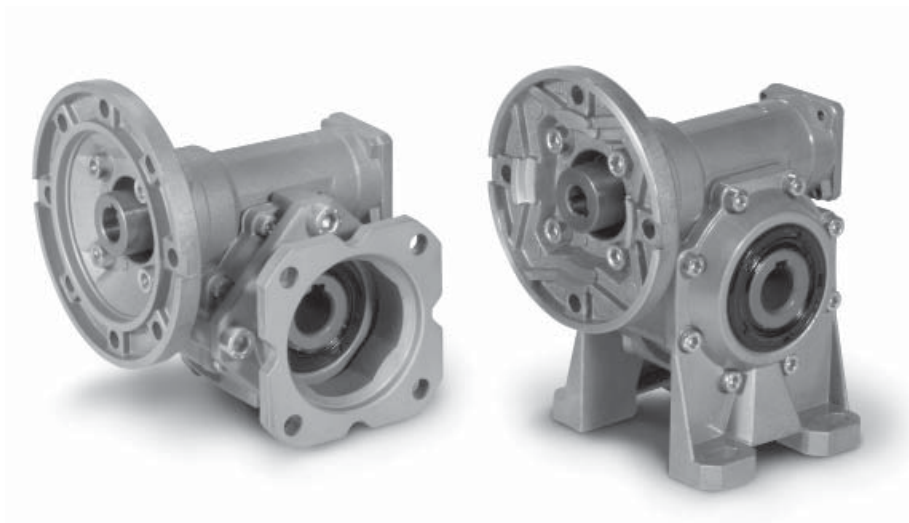

4	RIDUTTORI A VITE SENZA FINE BFK-BRK	BFK-BRK WORM GEARBOXES	SCHNECKENGETRIEBE BFK-BRK	
4.1	Caratteristiche	<i>Characteristics</i>	Merkmale	54
4.2	Designazione	<i>Designation</i>	Bezeichnung	54
4.3	Lubrificazione e posizioni di montaggio	<i>Lubrication and mounting position</i>	Schmierung und Einbaulage	55
4.4	Posizione morsettiera	<i>Terminal board position</i>	Lage des Klemmkasten	55
4.5	Dati tecnici	<i>Technical data</i>	Technische Daten	56
4.6	Momenti d'inerzia	<i>Moment of inertia</i>	Trägheitsmoment	61
4.7	Predisposizioni possibili	<i>Possible set-ups</i>	Mögliche Vorrichtungen	62
4.8	Dimensioni	<i>Dimensions</i>	Abmessungen	63
4.9	Accessori	<i>Accessories</i>	Zubehör	66
4.10	Limitatore di coppia cavo passante	<i>Torque limiter with through hollow shaft</i>	Drehmomentbegrenzer mit durchgehender Hohlwelle	67
4.11	Lista parti di ricambio	<i>Spare parts list</i>	Ersatzteilliste	69



4.1 Caratteristiche

I riduttori della serie a vite senza fine BFK - BRK si presentano estremamente leggeri grazie alla forma compatta e la carcassa realizzata in alluminio pressofuso. La serie presenta una svariata possibilità di versioni, con e senza piedi e con numerosi accessori che la rendono più versatile nell'impiego delle più svariate tipologie di applicazioni. La vite senza fine è in acciaio legato cementato-temprato ed è rettificata. La corona ha mozzo in ghisa con riporto di fusione in bronzo.

4.1 Characteristics

The BFK - BRK worm gearboxes are extremely light thanks to the compact shape of the housing made of cast aluminum. This series features a wide range of versions, with and without feet, with numerous accessories which make it extremely versatile for utilization in various applications. The worm shaft is ground and is made of hardened-casehardened compound steel. The worm wheel features a cast iron hub with bronze casting.



4.1 Merkmale

Die Schneckengetriebe der BFK - BRK Serie sind äußerst leicht dank der kompakten Form des Gehäuses aus Aluminiumguss. Die Serie bietet verschiedene Versionen mit und ohne Füße sowie zahlreiche Zubehörteile an, was zur vielseitigen Anwendbarkeit der Getriebe in vielerlei Applikationen dient. Die Schneckenwelle ist aus legierten gehärteten Einsatzstahl und ist geschliffen. Die Zahnkranz verfügt über eine Nabe aus Gusseisen mit Schmelzeinsatz aus Bronze.

4.2 Designazione

4.2 Designation

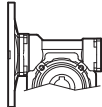
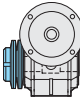
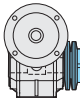
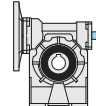
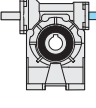
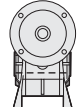
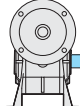
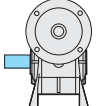
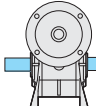
4.2 Bezeichnung

Riduttore Gearbox Getriebe	Grandezza Size Größe	Versione Version Ausführung	Rapporto rid. Ratio Untersetzung	Predispos.att. mot. Motor coupling Motoranschluss	Posizione di mont. Mounting position Einbaulage	Limitatore di coppia. Torque limiter Drehmomentbegrenzer	Seconda entrata Additional input Zusatzantrieb	Albero uscita Output shaft Abtriebswelle	Braccio di reazione Torque arm Drehmomentstütze
BFK	50	FS	10	80 B14	B3	LD	SeA	H	BR2
 BKF	30 40 50 63 75	A B V P F...S F...D	5 7.5 10 15 20 25 30 40 50 65 80 100	56 ÷ 112 B5 56 ÷ 112 B14	B3 B6 B7 B8 V5 V6	 LS  LD	  SeA	 H  SD  SS  DD	 BR2

Versioni

Versions

Ausführungen

BFK..A
BRK..A

BFK..B
BRK..B

BFK..V
BRK..V

BFK..P
BRK..P

BFK..F_S
BRK..F_S

BFK..F_D
BRK..F_D

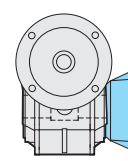
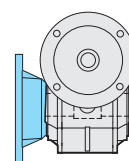
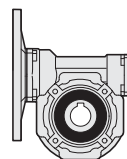
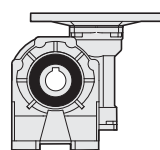
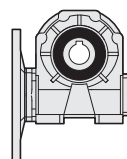
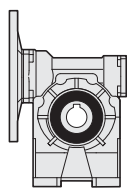

Specificare sempre in fase di ordinazione la versione.

Specify the version when ordering.

Bei der Bestellung immer die Bauform angeben.

4 BFK - BRK

4.3 Lubrificazione

Riduttori a vite senza fine BFK - BRK sono forniti tutti e sempre completi di lubrificante sintetico a base PAG con classe di viscosità ISO 320. Nei corpi in alluminio 30, 40, 50, 63, 75 è presente un solo tappo di riempimento olio.

4.3 Lubrication

BFK - BRK worm gearboxes are supplied with PAG synthetic lubricant featuring an ISO 320 viscosity class. Aluminium housings size 30, 40, 50, 63 and 75 have one filling plug only.

4.3 Schmierung

BFK - BRK Schneckengetriebe werden mit PAG synthetischen Schmierstoff Viskositätsklasse ISO 320 geliefert. Gehäuse aus Aluminium Größe 30, 40, 50, 63 und 75 verfügen über nur eine Einfüllschraube.

Quantità di lubrificante (litri)

Lubricant quantity (liters)

Schmiermittelmenge (Liter)

BFK BRK	B3	B6-B7	B8	V5-V6
30	0.015			
40	0.040			
50	0.080			
63	0.160			
75	0.260			

Posizioni di montaggio

Mounting positions

Bezeichnung

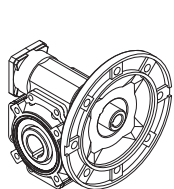

B3

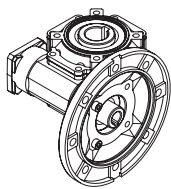

B6

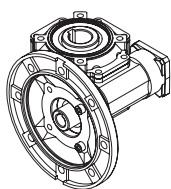

B7

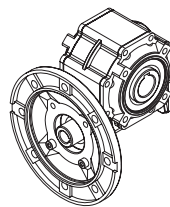

B8

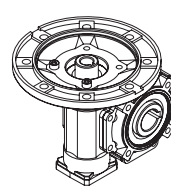

V5

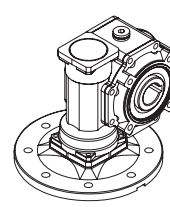

V6

4.4 Posizione morsettieria

4.4 Terminal board position

4.4 Lage der Klemmenkaste

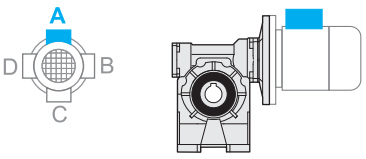
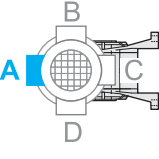
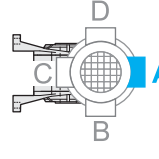
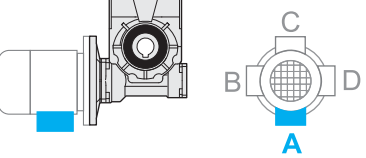
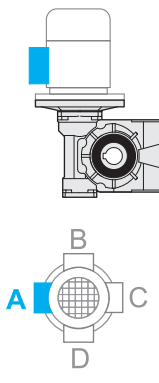
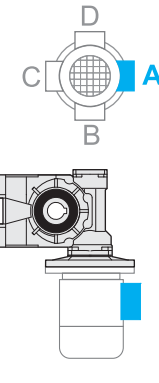
<p>B3</p> 	<p>B6</p> 	<p>B7</p> 
<p>B8</p> 	<p>V5</p> 	<p>V6</p> 

4.5 Dati tecnici

4.5 Technical data

4.5 Technische Daten

30	$n_1 = 2800$		BFK				BRK				
	i_n	n_2 [min ⁻¹]	T_2 [Nm]	P_1 [kW]	FS'	input IEC		T_{2M} [Nm]	P [kW]	R_d	P_{t0}
						B5	B14				
Kg 1.2	5	560	5.6	0.37	2.5	63 56		14	0.92	0.89	—
	7.5	373	8	0.37	2.0			16	0.72	0.86	—
	10	280	11	0.37	1.5			16	0.56	0.84	—
	15	187	15	0.37	1.1			17	0.41	0.81	—
	20	140	13	0.25	1.2			15	0.29	0.76	—
	25	112	16	0.25	1.0			16	0.25	0.74	—
	30	93	13	0.18	1.0	56		13	0.18	0.71	—
	40	70	16	0.18	1.0			16	0.18	0.65	—
	50	56	14	0.13	1.1			15	0.14	0.62	—
	65	43	17	0.13	1.0			17	0.13	0.57	—
	80	35	13	0.09	1.0			13	0.09	0.54	—
	100	28	16	0.09	0.8			12	0.07	0.52	—

30	$n_1 = 1400$		BFK				BRK				
	i_n	n_2 [min ⁻¹]	T_2 [Nm]	P_1 [kW]	FS'	input IEC		T_{2M} [Nm]	P [kW]	R_d	P_{t0}
						B5	B14				
Kg 1.2	5	280	6.5	0.22	2.9	63 56		19	0.64	0.87	0.40
	7.5	187	9	0.22	2.2			21	0.49	0.84	0.40
	10	140	12	0.22	1.8			22	0.40	0.82	0.40
	15	93	17	0.22	1.3			22	0.28	0.77	0.30
	20	70	18	0.18	1.1			19	0.19	0.72	0.20
	25	56	15	0.13	1.1			21	0.18	0.69	0.20
	30	47	18	0.13	1.4	56		20	0.15	0.66	0.20
	40	35	14	0.09	1.4			21	0.13	0.59	0.20
	50	28	17	0.09	1.1			19	0.10	0.55	0.20
	65	22	14	0.06	1.3			20	0.09	0.51	0.10
	80	18	16	0.06	1.1			17	0.06	0.48	0.10
	100	14	18	0.06	0.8			14	0.05	0.45	0.10

30	$n_1 = 900$		BFK				BRK				
	i_n	n_2 [min ⁻¹]	T_2 [Nm]	P_1 [kW]	FS'	input IEC		T_{2M} [Nm]	P [kW]	R_d	P_{t0}
						B5	B14				
Kg 1.2	5	180	5.9	0.13	3.9	63 56		23	0.51	0.85	—
	7.5	120	9	0.13	2.9			25	0.38	0.82	—
	10	90	11	0.13	2.3			25	0.30	0.80	—
	15	60	15	0.13	1.6			25	0.21	0.75	—
	20	45	19	0.13	1.2			22	0.15	0.69	—
	25	36	23	0.13	1.1			24	0.14	0.66	—
	30	30	18	0.09	1.2	56		21	0.10	0.63	—
	40	23	21	0.09	1.1			24	0.10	0.55	—
	50	18	16	0.06	1.3			21	0.08	0.52	—
	65	14	20	0.06	1.1			22	0.07	0.48	—
	80	11	11	0.03	1.7			19	0.05	0.44	—
	100	9	13	0.03	1.1			15	0.03	0.42	—

30	$n_1 = 500$		BFK				BRK				
	i_n	n_2 [min ⁻¹]	T_2 [Nm]	P_1 [kW]	FS'	input IEC		T_{2M} [Nm]	P [kW]	R_d	P_{t0}
						B5	B14				
Kg 1.2	5	100	—	—	—	63 56		29	0.36	0.83	—
	7.5	67	—	—	—			31	0.27	0.80	—
	10	50	—	—	—			31	0.21	0.77	—
	15	33	—	—	—			31	0.15	0.72	—
	20	25	—	—	—			26	0.10	0.66	—
	25	20	—	—	—			27	0.09	0.62	—
	30	17	—	—	—	56		25	0.07	0.59	—
	40	13	—	—	—			28	0.07	0.51	—
	50	10	—	—	—			25	0.06	0.48	—
	65	8	—	—	—			25	0.05	0.43	—
	80	6	—	—	—			20	0.03	0.40	—
	100	5	—	—	—			16	0.02	0.38	—

* **ATTENZIONE:** la coppia massima utilizzabile [T_{2M}] deve essere calcolata utilizzando il fattore di servizio: $T_{2M} = T_2 \times FS'$

* **WARNING:** Maximum allowable torque [T_{2M}] must be calculated using the following service factor: $T_{2M} = T_2 \times FS'$

* **ACHTUNG:** das max. anwendbare Drehmoment [T_{2M}] muss mit folgendem Betriebsfaktor berechnet werden: $T_{2M} = T_2 \times FS'$

4.5 Dati tecnici

4.5 Technical data

4.5 Technische Daten

40	n ₁ = 2800		BFK				BRK				
	i _n	n ₂ [min ⁻¹]	T ₂ [Nm]	P ₁ [kW]	FS'	input IEC		T _{2M} [Nm]	P [kW]	Rd	P _{t0}
						B5	B14				
Kg 2.0	5	560	11.3	0.75	2.2	71	63	25	1.67	0.88	—
	7.5	373	17	0.75	1.8			30	1.3	0.87	—
	10	280	22	0.75	1.4			31	1.1	0.86	—
	15	187	32	0.75	1.0			32	0.76	0.82	—
	20	140	30	0.55	1.0			31	0.57	0.80	—
	25	112	24	0.37	1.1			27	0.41	0.76	—
	30	93	28	0.37	1.3	35	0.47	0.73	—		
	40	70	24	0.25	1.4	33	0.35	0.70	—		
	50	56	28	0.25	1.1	30	0.27	0.65	—		
	65	43	24	0.18	1.2	63	56	28	0.21	0.61	—
	80	35	21	0.13	1.3			26	0.16	0.58	—
	100	28	24	0.13	1.0			25	0.13	0.55	—

40	n ₁ = 1400		BFK				BRK				
	i _n	n ₂ [min ⁻¹]	T ₂ [Nm]	P ₁ [kW]	FS'	input IEC		T _{2M} [Nm]	P [kW]	Rd	P _{t0}
						B5	B14				
Kg 2.0	5	280	16.3	0.55	2.1	71	63	34	1.14	0.87	0.80
	7.5	187	24	0.55	1.7			40	0.92	0.85	0.80
	10	140	31	0.55	1.3			41	0.73	0.83	0.70
	15	93	30	0.37	1.4			42	0.52	0.79	0.50
	20	70	38	0.37	1.0			40	0.39	0.76	0.50
	25	56	31	0.25	1.1			35	0.29	0.72	0.40
	30	47	35	0.25	1.3	41	0.29	0.68	0.40		
	40	35	38	0.22	1.1	38	0.22	0.64	0.30		
	50	28	36	0.18	1.0	38	0.19	0.59	0.30		
	65	22	31	0.13	1.1	63	56	35	0.15	0.54	0.20
	80	18	31	0.11	1.1			33	0.12	0.52	0.20
	100	14	30	0.09	0.9			28	0.08	0.49	0.20

40	n ₁ = 900		BFK				BRK				
	i _n	n ₂ [min ⁻¹]	T ₂ [Nm]	P ₁ [kW]	FS'	input IEC		T _{2M} [Nm]	P [kW]	Rd	P _{t0}
						B5	B14				
Kg 2.0	5	180	16.7	0.37	2.5	71	63	42	0.93	0.85	—
	7.5	120	25	0.37	2.0			48	0.72	0.83	—
	10	90	32	0.37	1.5			48	0.56	0.81	—
	15	60	45	0.37	1.1			49	0.40	0.76	—
	20	45	39	0.25	1.2			46	0.29	0.74	—
	25	36	33	0.18	1.3			42	0.23	0.69	—
	30	30	37	0.18	1.3	48	0.23	0.65	—		
	40	23	33	0.13	1.3	42	0.16	0.61	—		
	50	18	38	0.13	1.1	42	0.14	0.55	—		
	65	14	32	0.09	1.2	63	56	39	0.11	0.51	—
	80	11	37	0.09	1.0			37	0.09	0.48	—
	100	9	29	0.06	1.0			30	0.06	0.45	—

40	n ₁ = 500		BFK				BRK				
	i _n	n ₂ [min ⁻¹]	T ₂ [Nm]	P ₁ [kW]	FS'	input IEC		T _{2M} [Nm]	P [kW]	Rd	P _{t0}
						B5	B14				
Kg 2.0	5	100	7.1	0.09	7.1	71	63	51	0.64	0.83	—
	7.5	67	10	0.09	5.5			58	0.50	0.81	—
	10	50	14	0.09	4.4			59	0.39	0.79	—
	15	33	19	0.09	3.1			59	0.28	0.73	—
	20	25	24	0.09	2.3			55	0.20	0.70	—
	25	20	28	0.09	1.7			48	0.15	0.65	—
	30	17	31	0.09	1.8	58	0.17	0.61	—		
	40	13	39	0.09	1.3	52	0.12	0.57	—		
	50	10	44	0.09	1.2	51	0.11	0.51	—		
	65	8	52	0.09	0.9	63	56	45	0.08	0.46	—
	80	6	61*	0.09	0.7*			42	0.06	0.44	—
	100	5	71*	0.09	0.4*			32	0.04	0.41	—

* **ATTENZIONE:** la coppia massima utilizzabile [T_{2M}] deve essere calcolata utilizzando il fattore di servizio: T_{2M} = T₂ x FS'

* **WARNING:** Maximum allowable torque [T_{2M}] must be calculated using the following service factor: T_{2M} = T₂ x FS'

* **ACHTUNG:** das max. anwendbare Drehmoment [T_{2M}] muss mit folgendem Betriebsfaktor berechnet werden: T_{2M} = T₂ x FS'

4.5 Dati tecnici

4.5 Technical data

4.5 Technische Daten

50	n ₁ = 2800		BFK				BRK					
	i _n	n ₂ [min ⁻¹]	T ₂ [Nm]	P ₁ [kW]	FS'	input IEC		T _{2M} [Nm]	P [kW]	Rd	P _{t0}	
							B5	B14				
Kg 3.4	5	560	22.8	1.5	1.9	80	71	44	2.9	0.89	—	
	7.5	373	34	1.5	1.5			51	2.3	0.88	—	
	10	280	44	1.5	1.2			54	1.8	0.86	—	
	15	187	47	1.1	1.2			57	1.3	0.84	—	
	20	140	42	0.75	1.4			58	1.0	0.81	—	
	25	112	50	0.75	1.0			50	0.75	0.78	—	
	30	93	42	0.55	1.3	80-71-63	54	55	0.71	0.75	—	
	40	70	54	0.55	1.0			56	0.63	0.72	—	
	50	56	43	0.37	1.3			56	0.48	0.68	—	
	65	43	53	0.37	1.0			53	0.37	0.64	—	
	80	35	41	0.25	1.2			71	48	0.29	0.61	—
	100	28	35	0.18	1.3			63	45	0.23	0.58	—

50	n ₁ = 1400		BFK				BRK					
	i _n	n ₂ [min ⁻¹]	T ₂ [Nm]	P ₁ [kW]	FS'	input IEC		T _{2M} [Nm]	P [kW]	Rd	P _{t0}	
							B5	B14				
Kg 3.4	5	280	26.7	0.9	2.3	80	71	62	2.1	0.87	1.2	
	7.5	187	40	0.9	1.8			70	1.6	0.86	1.2	
	10	140	52	0.9	1.4			73	1.3	0.84	1.0	
	15	93	61	0.75	1.2			74	0.90	0.80	0.80	
	20	70	59	0.55	1.3			75	0.71	0.78	0.70	
	25	56	47	0.37	1.4			65	0.51	0.74	0.60	
	30	47	54	0.37	1.5	80-71-63	66	66	0.46	0.71	0.60	
	40	35	68	0.37	1.2			69	0.38	0.67	0.50	
	50	28	53	0.25	1.3			70	0.33	0.62	0.40	
	65	22	64	0.25	1.0			64	0.25	0.58	0.40	
	80	18	53	0.18	1.1			71	60	0.20	0.54	0.40
	100	14	45	0.13	1.2			63	55	0.16	0.51	0.30

50	n ₁ = 900		BFK				BRK				
	i _n	n ₂ [min ⁻¹]	T ₂ [Nm]	P ₁ [kW]	FS'	input IEC		T _{2M} [Nm]	P [kW]	Rd	P _{t0}
							B5	B14			
Kg 3.4	5	180	33.8	0.75	2.2	80	71	75	1.66	0.85	—
	7.5	120	50	0.75	1.6			83	1.23	0.84	—
	10	90	66	0.75	1.3			86	0.98	0.82	—
	15	60	68	0.55	1.3			88	0.71	0.78	—
	20	45	59	0.37	1.5			87	0.54	0.75	—
	25	36	70	0.37	1.1			75	0.40	0.71	—
	30	30	79	0.37	1.0	80-71-63	79	79	0.37	0.67	—
	40	23	67	0.25	1.1			75	0.28	0.63	—
	50	18	78	0.25	1.0			80	0.26	0.59	—
	65	14	67	0.18	1.1			74	0.20	0.54	—
	80	11	56	0.13	1.2			67	0.16	0.51	—
	100	9	45	0.09	1.3			58	0.12	0.47	—

50	n ₁ = 500		BFK				BRK				
	i _n	n ₂ [min ⁻¹]	T ₂ [Nm]	P ₁ [kW]	FS'	input IEC		T _{2M} [Nm]	P [kW]	Rd	P _{t0}
							B5	B14			
Kg 3.4	5	100	14.3	0.18	6.4	80	71	92	1.15	0.84	—
	7.5	67	21	0.18	4.7			100	0.85	0.82	—
	10	50	28	0.18	3.8			104	0.68	0.80	—
	15	33	39	0.18	2.7			106	0.49	0.75	—
	20	25	50	0.18	2.1			104	0.38	0.72	—
	25	20	58	0.18	1.5			88	0.27	0.68	—
	30	17	65	0.18	1.5	80-71-63	98	98	0.27	0.63	—
	40	13	81	0.18	1.2			95	0.21	0.59	—
	50	10	93	0.18	1.0			94	0.18	0.54	—
	65	8	56	0.09	1.5			86	0.14	0.50	—
	80	6	63	0.09	1.2			77	0.11	0.46	—
	100	5	74	0.09	0.8			63	61	0.07	0.43

* **ATTENZIONE:** la coppia massima utilizzabile [T_{2M}] deve essere calcolata utilizzando il fattore di servizio: T_{2M} = T₂ x FS'

* **WARNING:** Maximum allowable torque [T_{2M}] must be calculated using the following service factor: T_{2M} = T₂ x FS'

* **ACHTUNG:** das max. anwendbare Drehmoment [T_{2M}] muss mit folgendem Betriebsfaktor berechnet werden: T_{2M} = T₂ x FS'



4.5 Dati tecnici

4.5 Technical data

4.5 Technische Daten

63	n ₁ = 2800		BFK				BRK				
	i _n	n ₂ [min ⁻¹]	T ₂ [Nm]	P ₁ [kW]	FS'	input IEC		T _{2M} [Nm]	P [kW]	Rd	P _{t0}
						B5	B14				
Kg 6.3	5	560	45.5	3	1.7	80	90	79	5.2	0.89	—
	7.5	373	68	3	1.3			88	3.9	0.88	—
	10	280	89	3	1.1			94	3.2	0.87	—
	15	187	95	2.2	1.0			98	2.3	0.84	—
	20	140	85	1.5	1.3			110	1.9	0.83	—
	25	112	76	1.1	1.2			93	1.4	0.81	—
	30	93	87	1.1	1.3	110	1.4	0.77	—		
	40	70	111	1.1	1.1	71	80	117	1.2	0.74	—
	50	56	90	0.75	1.1			97	0.81	0.70	—
	65	43	81	0.55	1.2			98	0.66	0.67	—
	80	35	65	0.37	1.4			91	0.52	0.64	—
	100	28	75	0.37	1.1			83	0.41	0.60	—

63	n ₁ = 1400		BFK				BRK				
	i _n	n ₂ [min ⁻¹]	T ₂ [Nm]	P ₁ [kW]	FS'	input IEC		T _{2M} [Nm]	P [kW]	Rd	P _{t0}
						B5	B14				
Kg 6.3	5	280	54	1.8	2.0	80	90	111	3.7	0.88	1.8
	7.5	187	80	1.8	1.5			120	2.7	0.87	1.8
	10	140	105	1.8	1.2			127	2.2	0.85	1.6
	15	93	125	1.5	1.1			130	1.6	0.81	1.2
	20	70	120	1.1	1.2			144	1.3	0.80	1.2
	25	56	118	0.9	1.0			118	0.90	0.77	1.0
	30	47	134	0.9	1.1	142	0.95	0.73	0.90		
	40	35	142	0.75	1.1	71	80	150	0.79	0.69	0.80
	50	28	122	0.55	1.0			122	0.55	0.65	0.70
	65	22	100	0.37	1.2			122	0.45	0.61	0.60
	80	18	79	0.25	1.4			113	0.36	0.58	0.60
	100	14	91	0.25	1.1			102	0.28	0.53	0.50

63	n ₁ = 900		BFK				BRK				
	i _n	n ₂ [min ⁻¹]	T ₂ [Nm]	P ₁ [kW]	FS'	input IEC		T _{2M} [Nm]	P [kW]	Rd	P _{t0}
						B5	B14				
Kg 6.3	5	180	69	1.5	1.9	80	90	135	2.9	0.87	—
	7.5	120	102	1.5	1.4			144	2.1	0.85	—
	10	90	133	1.5	1.1			150	1.7	0.83	—
	15	60	139	1.1	1.1			152	1.2	0.79	—
	20	45	123	0.75	1.4			167	1.0	0.77	—
	25	36	109	0.55	1.3			140	0.71	0.74	—
	30	30	122	0.55	1.3	164	0.74	0.70	—		
	40	23	154	0.55	1.1	71	80	171	0.61	0.66	—
	50	18	120	0.37	1.2			141	0.44	0.61	—
	65	14	98	0.25	1.4			139	0.35	0.57	—
	80	11	115	0.25	1.1			128	0.28	0.54	—
	100	9	95	0.18	1.2			115	0.22	0.50	—

63	n ₁ = 500		BFK				BRK				
	i _n	n ₂ [min ⁻¹]	T ₂ [Nm]	P ₁ [kW]	FS'	input IEC		T _{2M} [Nm]	P [kW]	Rd	P _{t0}
						B5	B14				
Kg 6.3	5	100	20	0.25	8.3	80	90	169	2.08	0.85	—
	7.5	67	30	0.25	5.9			177	1.5	0.83	—
	10	50	39	0.25	4.7			182	1.2	0.81	—
	15	33	55	0.25	3.4			184	0.84	0.76	—
	20	25	71	0.25	2.8			200	0.70	0.74	—
	25	20	85	0.25	1.9			165	0.49	0.71	—
	30	17	94	0.25	2.1	195	0.52	0.65	—		
	40	13	118	0.25	1.7	71	80	201	0.43	0.62	—
	50	10	135	0.25	1.2			165	0.31	0.56	—
	65	8	163	0.25	1.0			161	0.25	0.52	—
	80	6	137	0.18	1.1			148	0.19	0.50	—
	100	5	77	0.09	1.6			122	0.14	0.45	—

* **ATTENZIONE:** la coppia massima utilizzabile [T_{2M}] deve essere calcolata utilizzando il fattore di servizio: T_{2M} = T₂ x FS'

* **WARNING:** Maximum allowable torque [T_{2M}] must be calculated using the following service factor: T_{2M} = T₂ x FS'

* **ACHTUNG:** das max. anwendbare Drehmoment [T_{2M}] muss mit folgendem Betriebsfaktor berechnet werden: T_{2M} = T₂ x FS'

75	$n_1 = 2800$		BFK				BRK				
	i_n	n_2 [min ⁻¹]	T_2 [Nm]	P_1 [kW]	FS'	input IEC		T_{2M} [Nm]	P [kW]	Rd	P_{t0}
						B5	B14				
Kg 7.6	7.5	373	125	5.5	1.0			131	5.8	0.89	—
	10	280	120	4	1.2	90		143	4.8	0.88	—
	15	187	131	3	1.2	100		152	3.5	0.85	—
	20	140	171	3	1.0	112		172	3.0	0.84	—
	25	112	154	2.2	1.0			155	2.2	0.82	—
	30	93	120	1.5	1.4	71(B5)-80-90-100-112		170	2.1	0.78	—
	40	70	154	1.5	1.2	80		183	1.8	0.75	—
	50	56	136	1.1	1.2	90		166	1.3	0.73	—
	65	43	114	0.75	1.4	71	80	155	1.0	0.69	—
	80	35	135	0.75	1.1	80	90	145	0.80	0.66	—
	100	28	159	0.75	0.8	90		131	0.62	0.62	—

75	$n_1 = 1400$		BFK				BRK				
	i_n	n_2 [min ⁻¹]	T_2 [Nm]	P_1 [kW]	FS'	input IEC		T_{2M} [Nm]	P [kW]	Rd	P_{t0}
						B5	B14				
Kg 7.6	7.5	187	178	4	1.0			180	4.0	0.87	2.5
	10	140	176	3	1.1	90		193	3.3	0.86	2.3
	15	93	187	2.2	1.1	100		202	2.4	0.83	1.9
	20	70	199	1.8	1.1	112		226	2.0	0.81	1.7
	25	56	200	1.5	1.0			202	1.5	0.78	1.5
	30	47	167	1.1	1.3	71(B5)-80-90-100-112		220	1.5	0.74	1.2
	40	35	213	1.1	1.1	80		235	1.2	0.71	1.1
	50	28	206	0.9	1.0	90		211	0.92	0.67	1.0
	65	22	154	0.55	1.3	71	80	195	0.70	0.63	0.90
	80	18	180	0.55	1.0	80	90	182	0.55	0.60	0.80
	100	14	210	0.55	0.8	90		182	0.43	0.56	0.70

75	$n_1 = 900$		BFK				BRK				
	i_n	n_2 [min ⁻¹]	T_2 [Nm]	P_1 [kW]	FS'	input IEC		T_{2M} [Nm]	P [kW]	Rd	P_{t0}
						B5	B14				
Kg 7.6	7.5	120	205	3	1.0			215	3.1	0.86	—
	10	90	197	2.2	1.2	90		229	2.6	0.84	—
	15	60	231	1.8	1.0	100		237	1.9	0.81	—
	20	45	250	1.5	1.1	112		263	1.6	0.78	—
	25	36	221	1.1	1.1			233	1.2	0.76	—
	30	30	249	1.1	1.0	71(B5)-80-90-100-112		254	1.1	0.71	—
	40	23	214	0.75	1.3	80		270	0.94	0.67	—
	50	18	186	0.55	1.3	90		241	0.71	0.64	—
	65	14	151	0.37	1.5	71	80	221	0.54	0.59	—
	80	11	177	0.37	1.2	80	90	205	0.43	0.56	—
	100	9	203	0.37	0.9	90		184	0.34	0.52	—

75	$n_1 = 500$		BFK				BRK				
	i_n	n_2 [min ⁻¹]	T_2 [Nm]	P_1 [kW]	FS'	input IEC		T_{2M} [Nm]	P [kW]	Rd	P_{t0}
						B5	B14				
Kg 7.6	7.5	67	90	0.75	2.9			265	2.2	0.84	—
	10	50	118	0.75	2.4	90		279	1.8	0.82	—
	15	33	167	0.75	1.7	100		286	1.3	0.78	—
	20	25	216	0.75	1.5	112		315	1.1	0.75	—
	25	20	260	0.75	1.1			278	0.80	0.72	—
	30	17	288	0.75	1.1	71(B5)-80-90-100-112		302	0.79	0.67	—
	40	13	265	0.55	1.2	80		317	0.66	0.63	—
	50	10	210	0.37	1.3	90		282	0.50	0.59	—
	65	8	251	0.37	1.0	71	80	257	0.38	0.55	—
	80	6	197	0.25	1.2	80	90	238	0.30	0.52	—
	100	5	161	0.18	1.3	90		206	0.23	0.47	—

* **ATTENZIONE:** la coppia massima utilizzabile [T_{2M}] deve essere calcolata utilizzando il fattore di servizio: $T_{2M} = T_2 \times FS'$

* **WARNING:** Maximum allowable torque [T_{2M}] must be calculated using the following service factor: $T_{2M} = T_2 \times FS'$

* **ACHTUNG:** das max. anwendbare Drehmoment [T_{2M}] muss mit folgendem Betriebsfaktor berechnet werden: $T_{2M} = T_2 \times FS'$



4.6 **Momenti d' inerzia** [Kg·cm²]
(riferiti all'albero veloce in entrata)

4.6 **Moments of inertia** [Kg·cm²]
(referred to input shaft)

4.6 **Trägheitsmoment** [Kg·cm²]
(bez. Antriebswelle)

30

i _n	BRK	BFK	
		B5 - B14	
		IEC 56	IEC 63
7.5	0.058	0.112	0.109
10	0.049	0.103	0.100
15	0.042	0.097	0.094
20	0.039	0.095	0.092
25	0.038	0.094	0.091
30	0.038	0.093	0.090
40	0.037	0.093	0.090
50	0.037	0.092	0.089
65	0.024	0.079	-
80	0.024	0.079	-
100	0.024	0.078	-

40

i _n	BRK	BFK		
		B5 - B14		
		IEC 56	IEC 63	IEC 71
7.5	0.170	-	0.321	0.356
10	0.144	-	0.272	0.347
15	0.125	-	0.266	0.340
20	0.094	-	0.263	0.338
25	0.091	-	0.262	0.337
30	0.113	-	0.262	0.337
40	0.087	-	0.261	0.337
50	0.087	0.182	0.261	-
65	0.069	0.182	0.261	-
80	0.069	0.182	0.261	-
100	0.068	0.182	0.261	-

50

i _n	BRK	BFK		
		B5 - B14		
		IEC 63	IEC 71	IEC 80
7.5	0.499	-	0.684	0.935
10	0.417	-	0.602	0.853
15	0.358	-	0.543	0.794
20	0.281	-	0.523	0.774
25	0.272	-	0.513	0.764
30	0.323	-	0.508	0.759
40	0.262	0.311	0.503	0.755
50	0.183	0.311	0.501	-
65	0.136	0.311	0.499	-
80	0.136	0.310	0.498	-
100	0.135	0.309	0.498	-

63

i _n	BRK	BFK		
		B5 - B14		
		IEC 71	IEC 80	IEC 63
7.5	1.363	-	1.949	2.269
10	1.158	-	1.744	2.063
15	1.011	-	1.597	1.916
20	0.710	-	1.545	1.864
25	0.679	-	1.514	1.833
30	0.922	-	1.508	1.828
40	0.660	0.958	1.495	-
50	0.653	0.958	1.488	-
65	0.552	0.955	1.484	-
80	0.550	0.953	1.482	-
100	0.549	0.952	1.481	-

75

i _n	BRK	BFK			
		B5 - B14			
		IEC 71	IEC 80	IEC 90	IEC 100-112
7.5	2.970	-	-	3.712	4.462
10	2.492	-	-	3.234	3.984
15	2.151	-	-	2.893	3.643
20	1.567	-	-	2.774	3.523
25	1.501	-	-	2.709	3.458
30	1.946	1.615	1.575	2.689	3.438
40	1.451	-	1.573	2.659	-
50	1.435	-	1.570	2.642	-
65	1.158	1.609	1.569	2.633	-
80	1.153	1.605	1.565	2.629	-
100	1.150	1.602	1.562	2.626	-

4.7 Predisposizioni possibili

4.7 Possible set-ups

4.7 Mögliche Vorrichtungen

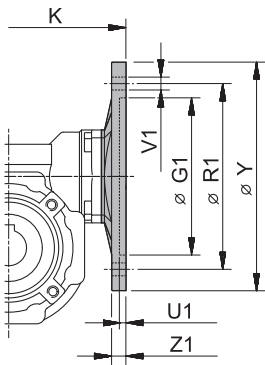

BFK	PAM IEC	G ₁	K	R ₁	U ₁	V1			Y	Z ₁	Diametro fori PAM / Holes diameter IEC-Input Bohrungsdurchmesser IEC-Antrieb																			
						∅					7.5	10	15	20	25	30	40	50	65	80	100									
30	56 B5	80	57	100	4	7	n° 8		120	8	9	9	9	9	9	9	9	9	9	9	9	9	9	9	9	9	9	9		
	56 B14	50		65	3.5	6	n° 8		80	8	9	9	9	9	9	9	9	9	9	9	9	9	9	9	9	9	9	9	9	9
	63 B5	95		115	4	9	n° 8		140	8	11	11	11	11	11	11	11	11	11	11	11	11	11	11	11	11	11	11	11	11
	63 B14	60		75	4	6	n° 8		90	8	11	11	11	11	11	11	11	11	11	11	11	11	11	11	11	11	11	11	11	11
40	56 B5	80	75	100	4	7	n° 8		120	9	/	/	/	/	/	/	/	/	9	9	9	9	9	9	9	9	9	9		
	56 B14	50		65	3.5	6		n° 4	80	8	/	/	/	/	/	/	/	/	9	9	9	9	9	9	9	9	9	9	9	
	63 B5	95		115	4	9	n° 8		140	9	11	11	11	11	11	11	11	11	11	11	11	11	11	11	11	11	11	11	11	
	63 B14	60		75	3.5	6		n° 4	90	8	11	11	11	11	11	11	11	11	11	11	11	11	11	11	11	11	11	11	11	
	71 B5	110		130	4.5	9	n° 8		160	10	14	14	14	14	14	14	14	14	14	/	/	/	/	/	/	/	/	/	/	
	71 B14	70		85	3.5	7	n° 8		105	8	14	14	14	14	14	14	14	14	14	/	/	/	/	/	/	/	/	/	/	/
50	63 B5	95	82	115	4	9	n° 8		140	9	/	/	/	/	/	/	/	11	11	11	11	11	11	11	11	11	11	11		
	63 B14	60		75	3.5	6		n° 4	90	8	/	/	/	/	/	/	/	/	11	11	11	11	11	11	11	11	11	11	11	
	71 B5	110		130	4.5	9	n° 8		160	10	14	14	14	14	14	14	14	14	14	14	14	14	14	14	14	14	14	14	14	
	71 B14	70		85	3.5	7	(n° 8)*	n° 4	105	8	14	14	14	14	14	14	14	14	14	14	14	14	14	14	14	14	14	14	14	
	80 B5	130		165	4.5	11	n° 8		200	10	19	19	19	19	19	19	19	19	19	/	/	/	/	/	/	/	/	/		
	80 B14	80		100	4	7	n° 8		120	10	19	19	19	19	19	19	19	19	19	/	/	/	/	/	/	/	/	/		
63	71 B5	110	97	130	4.5	9	n° 8		160	10	/	/	/	/	/	/	/	14	14	14	14	14	14	14	14	14	14	14		
	71 B14	70		85	3.5	7		n° 4	105	10	/	/	/	/	/	/	/	/	14	14	14	14	14	14	14	14	14	14		
	80 B5	130		165	4.5	11	n° 8		200	10	19	19	19	19	19	19	19	19	19	19	19	19	19	19	19	19	19	19		
	80 B14	80		100	4	7		n° 4	120	10	19	19	19	19	19	19	19	19	19	19	19	19	19	19	19	19	19	19		
	90 B5	130		165	4.5	11	n° 8		200	10	24	24	24	24	24	24	24	24	24	/	/	/	/	/	/	/	/	/		
	90 B14	95		115	4	8.5	n° 8		140	10	24	24	24	24	24	24	24	24	24	/	/	/	/	/	/	/	/	/		
75	71 B5	110	114	130	4.5	9	n° 8		160	10	/	/	/	/	/	/	14	/	/	14	14	14	14	14	14	14	14			
	80 B5	130		165	4.5	11	n° 8		200	10	/	/	/	/	/	/	19	19	19	19	19	19	19	19	19	19	19			
	80 B14	80		100	4	7		n° 4	120	11	/	/	/	/	/	/	19	19	19	19	19	19	19	19	19	19	19			
	90 B5	130		165	4.5	11	n° 8		200	10	24	24	24	24	24	24	24	24	24	24	24	24	24	24	24	24	24			
	90 B14	95		115	4	9		n° 4	140	11	24	24	24	24	24	24	24	24	24	24	24	24	24	24	24	24	24			
	100/112 B5	180		215	5	14	n° 8		250	13	28	28	28	28	28	28	28	28	28	/	/	/	/	/	/	/	/			
	100 B14	110		130	4.5	9	n° 8		160	11	28	28	28	28	28	28	28	28	28	/	/	/	/	/	/	/	/			

* A richiesta, solo con corpo speciale / Upon request, only with special body / Auf Wunsch nur mit speziellen Körper



BFK.../A

BRK.../A

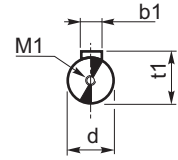
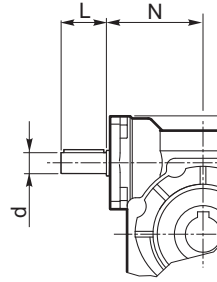
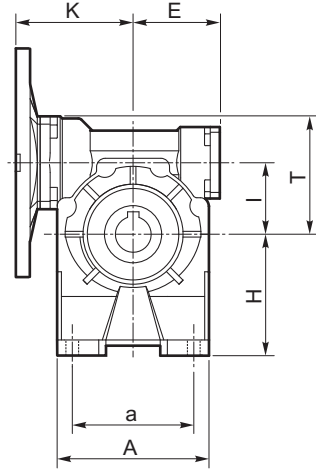
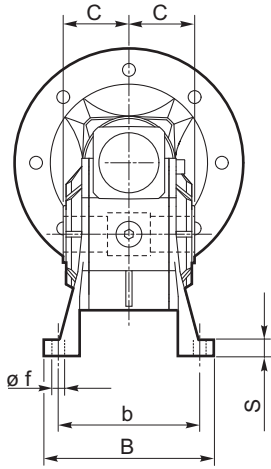

BRK	Albero entrata Input shaft Eingangswelle			
	d (j6)	b1	t1	M1
30	9	3	10.2	M4x10
40	11	4	12.5	M4x10
50	14	5	16	M5x13
63	18	6	20.5	M6x16
75	19	6	21.5	M6x16

BFK.../B

BRK.../B

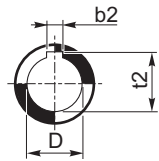
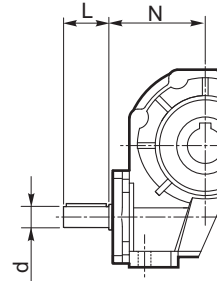
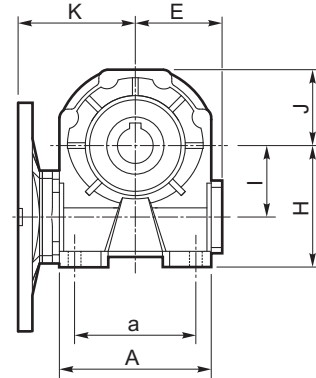
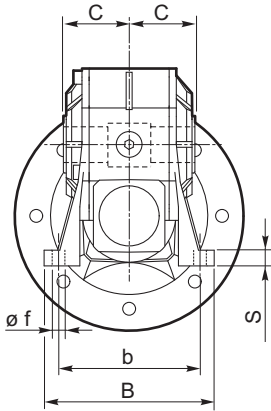

BFK BRK	Albero lento cavo Hollow output shaft Ausgangshohlwelle		
	D H7	b2	t2
30	14	5	16.3
40	18	6	20.8
50	25	8	28.3
63	25	8	28.3
75	28 (30)	8 (8)	31.3 (33.3)

BFK.../V

BRK.../V

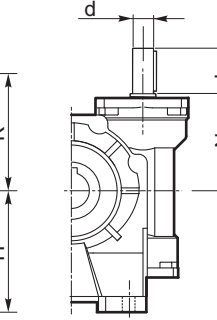
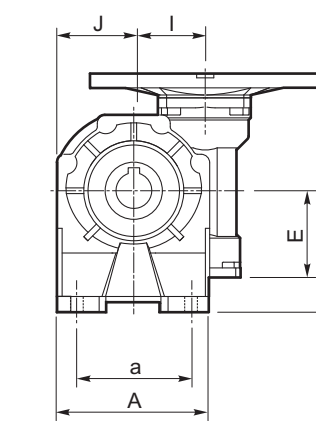
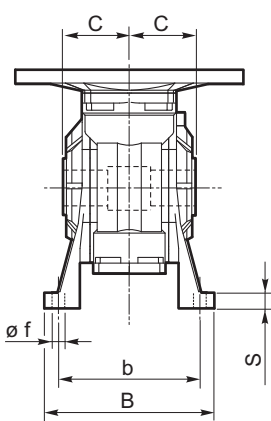

A, B, V

BFK BRK	A	a	B	b	C	E	f	H	I	J	K	L	N	s	T
30	67	52 ÷ 40	78	66	27.5	41	6.5	55	31.5	37.5	57	20	47	8	52.5
40	86.5	52	98	81	32	51	8.5	72	40	43.5	75	22	64	10	68.5
50	107	63	118	98.5	41	60	9	82	50	53.5	82	30	74	10	82.5
63	127.5	95	136	111	60	71	11	100	63	64	97	45	80	12	100.5
75	155.5	120	140	112 ÷ 120	60	85	11	115	75	78	114	40	98	12	116.5

BFK.../P

BRK.../P

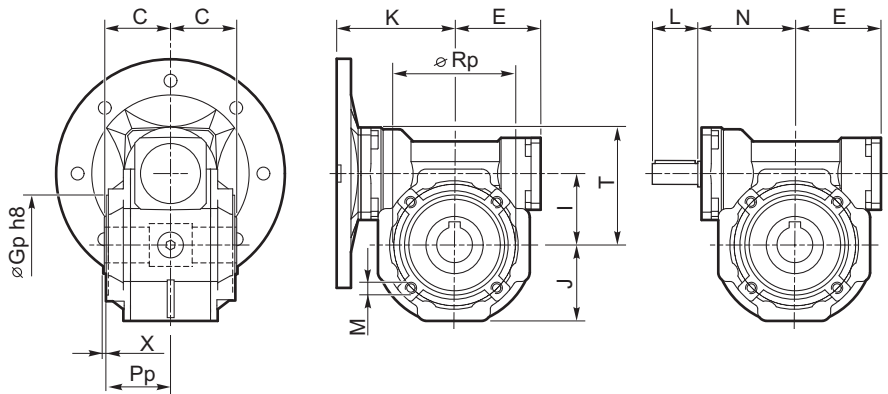

Flangia pendolare / Side cover for shaft mounting / Flansch für Drehmomentstütze

30 - 40 - 50

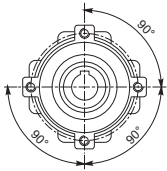

4 Fori / Holes / Bohrungen

63 - 75

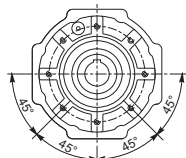

8 Fori / Holes / Bohrungen

P					
BFK BRK	30	40	50	63	75
G_p h8	50	50	68	75	90
M	M6x8	M6X10	M6x8	M8x14	M8x14
P_p	30	38	44	45	46
R_p	65	65	94	90	110
X	1.5	1.5	2	10	13

P								
BFK BRK	C	E	I	J	K	L	N	T
30	27.5	41	31.5	37.5	57	20	47	52.5
40	32	51	40	43.5	75	22	64	68.5
50	41	60	50	53.5	82	30	74	82.5
63	60	71	63	64	97	45	80	100.5
75	60	85	75	78	114	40	98	116.5



Flangia uscita / Output flange / Abtriebsflansch

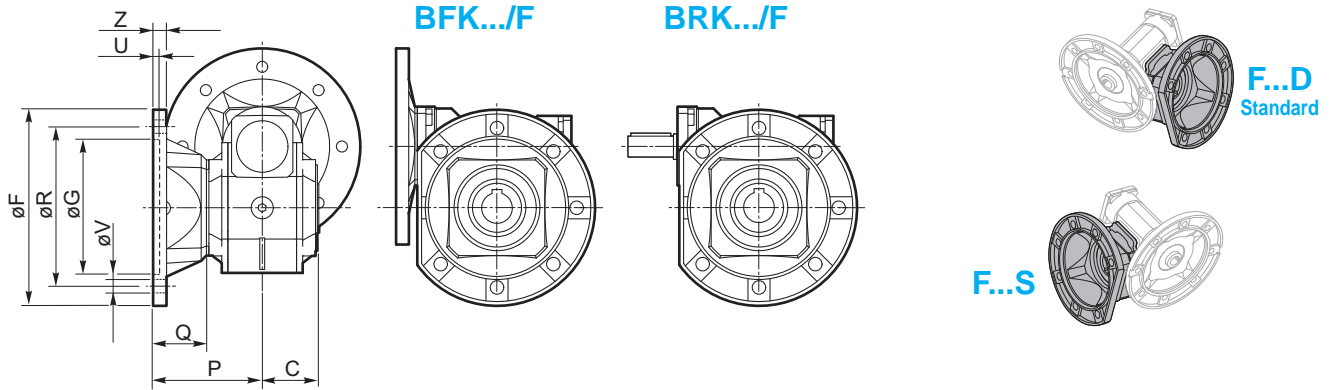

Tipo flangia / Type flange / Typ Flansch

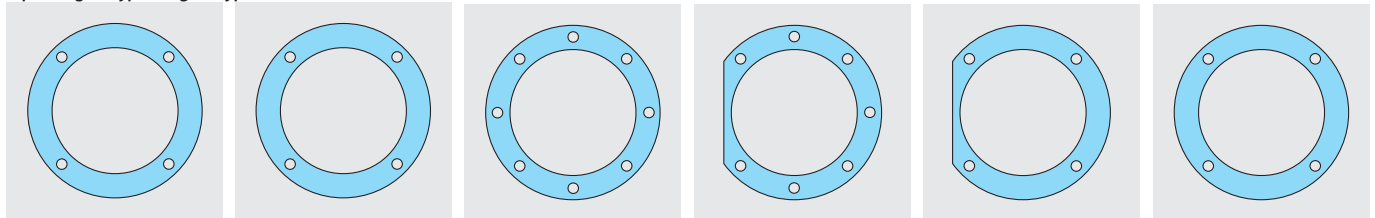

30	40	50	63	63	75	63	75	63	75
F	F	F - F1	F	F1	F - F1	F2	F2 - F3 F3A	F3	F4

BFK BRK	Tipo flangia Type flange Typ flansch	C	F		G (H8)	P	Q	R	U	V			Z
												Ø	
30	F	27.5	82		50	50.5	23	68	3.5	n° 4		6.0	6
40	F	32	110		60	60	28	87	5	n° 4		9	8
50	F	41	125		70	85	44	90	5	n° 4		10.5	10
	F1		125		70	115	74	90	5	n° 4		10.5	10
63	F	60	180		115	116	56	150	7		n° 8	11	12
	F1		180		115	86	26	150	5		n° 7	11	11
	F2		200		130	102	42	165	6	n° 4		13	11
	F3		160		110	82	22	130	5	n° 4		11	11
75	F	60	200		130	111	51	165	6		n° 7	13	13
	F1		200		130	85	25	165	6		n° 7	13	13
	F2		175		115	116	56	150	6	n° 4		11	12
	F3		175		115	85	25	150	5	n° 4		11	12
	F3A		160		110	85	25	130	5	n° 4		11	12
	F4		160		110	101	41	130	6	n° 4		11	12

4.9 Accessori

4.9 Accessories

4.9 Zubehör

Albero lento semplice / *Single output shaft* / Standard Abtriebswelle

Albero lento doppio / *Double output shaft* / Doppelte Abtriebswelle

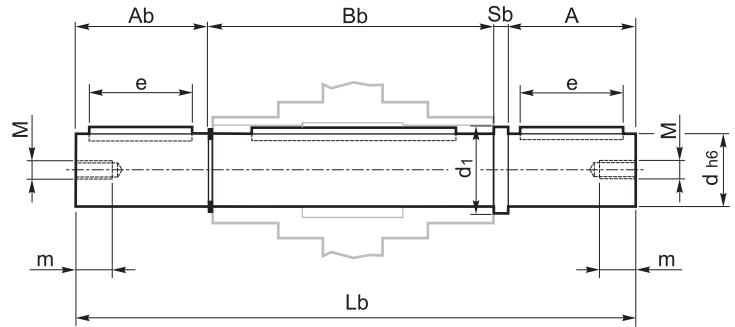
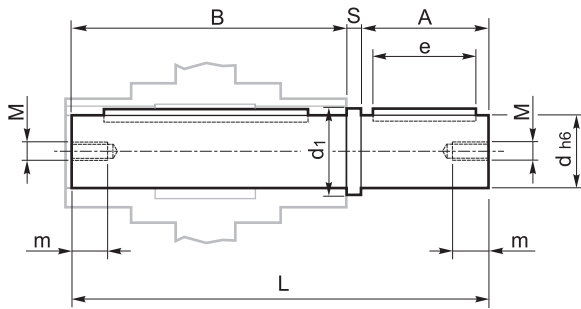

BFK BRK	A	Ab	B	Bb	d (h6)	d1	e	L	Lb	M	m	S	Sb
30	30	29	52	56	14	18.5	20	84.5	117.5	M6	16	2.5	2.5
40	40	39	62	65.2	18	24.5	30	105	147.2	M6	16	3	3
50	60	59	80	83.2	25	29.5	50	143.5	205.7	M8	22	3.5	3.5
63	60	59	119	121.2	25	29.5	50	183	244.2	M8	22	4	4
75	60	59	119	121.5	28	34.5	50	183	244.5	M8	22	4	4

Braccio di reazione / *Torque arm* / Drehmomentstütze

BR2 Con boccola / *With bush* / Mit Büchse

BFK BRK	a	b	D1	E	H2	K2	Lt	O	S1	S2
30	100	40	50	65	8	24.5	157.5	7	15	4
40	100	40	50	65	8	32.5	157.5	7	15	4
50	100	55	68	94	8	38.5	175	7	15	4
63	150	55	75	90	10	38	233	9	20	6
75	200	63	90	110	10	36.5	300	9	25	6

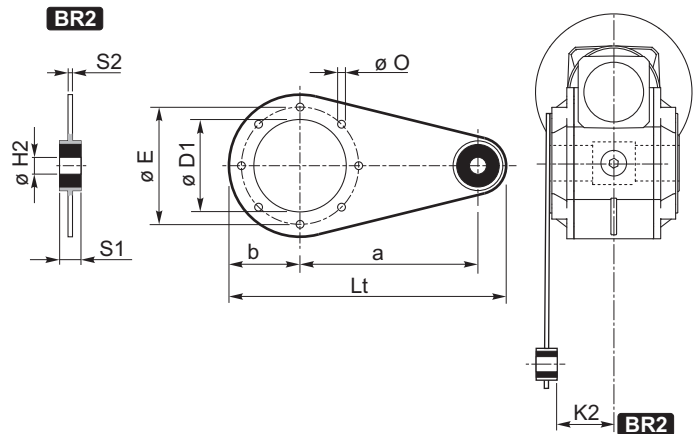

Entrata supplementare
(vite bisorgente)

Additional input
(double extended input shaft)

Zusatzantrieb
(beidseitige Welle)

S.e.A.

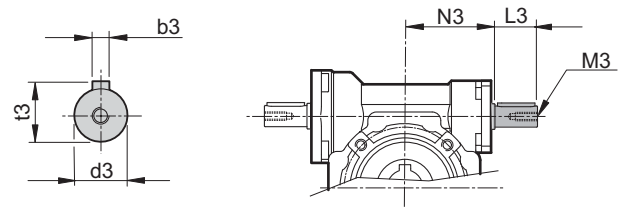
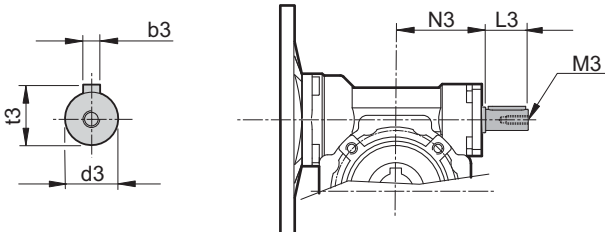

BFK	d3 (j6)	L3	M3	N3	b3	t3
30	9	15	M4x10	42.5	3	10.2
40	11	20	M4x12	52.5	4	12.5
50	14	25	M5x13	62.5	5	16
63	19	30	M8x20	72.5	6	21.5
75	24	40	M8x20	89	8	27

BRK	d3 (j6)	L3	M3	N3	b3	t3
30	9	20	M4x10	42.5	3	10.2
40	11	22	M4x10	52.5	4	12.5
50	14	30	M5x13	62.5	5	16
63	18	45	M6x16	72.5	6	20.5
75	19	40	M6x16	89	6	21.5

Opzioni disponibili:

Available options:

Auf Anfrage ist folgendes Zubehör
erhältlich:

Cuscinetti a rulli conici corona

Tapered roller bearing for worm wheel

Kegelrollenlager für Schneckenrad

4.10 Limitatore di coppia cavo passante

Il limitatore di coppia viene consigliato in tutte quelle applicazioni che richiedono una limitazione sulla coppia trasmissibile per proteggere l'impianto e/o preservare il riduttore evitando sovraccarichi o urti indesiderati quanto inaspettati.

È un dispositivo con albero dotato di cavo passante, con funzionamento a frizione, ed è integrato al riduttore, presentando un ingombro limitato.

Concepito per lavorare a bagno d'olio, il dispositivo risulta affidabile nel tempo ed è esente da usura se non viene mantenuto in condizioni prolungate di slittamento (condizione che si verifica quando la coppia presenta valori superiori a quelli di taratura).

La taratura è facilmente regolabile dall'esterno attraverso il serraggio di una ghiera autobloccante che porta a compressione le 4 molle a tazza disposte tra loro in serie.

Il dispositivo non consente:

- l'impiego di cuscinetti a rulli conici in uscita
- funzionamento prolungato in condizioni di slittamento.

Nella tabella seguente vengono riportati i valori delle coppie di slittamento M_{2S} in funzione del n° di giri della ghiera.

I valori di taratura presentano una tolleranza del $\pm 10\%$ e si riferiscono ad una condizione statica.

In condizioni dinamiche è da notare che la coppia di slittamento assume valori diversi a seconda del tipo e/o modalità in cui si verifica il sovraccarico: con valori maggiori in caso di carico uniformemente crescente rispetto a valori più contenuti in seguito al verificarsi di picchi improvvisi di carico.

NOTA: quando si supera il valore di taratura si ha slittamento. Il coefficiente di attrito tra le superfici di contatto da statico diventa dinamico e la coppia trasmessa cala del 30% circa.

È quindi opportuno prevedere uno stop per poter ripartire al valore di taratura iniziale.

È importante notare che la coppia di slittamento non resta sempre la medesima durante tutta la vita del limitatore.

Tende infatti a diminuire in rapporto al numero e alla durata degli slittamenti che, rodando le superfici di contatto, ne aumentano il rendimento.

È quindi opportuno verificare periodicamente, soprattutto durante la fase di rodaggio, la taratura del dispositivo.

Là dove sia richiesto un errore più contenuto nella taratura, è necessario testare la coppia trasmissibile sull'impianto.

Il dispositivo viene consegnato tarato alla coppia riportata a catalogo T_{2M} salvo diversa indicazione espressa in fase di ordinazione.

4.10 Torque limiter with through hollow shaft

The use of a torque limiter is advisable when the application requires the limitation of the transmissible torque to safeguard the plant and/or the gearbox from unexpected or undesired overloads.

The torque limiter is equipped with a through hollow shaft and a friction clutch. It is integrated in the gearbox, therefore space requirement is limited.

Designed to be working in oil bath, the device is reliable over time and is not subject to wear unless in case of operation with prolonged slipping (it occurs when the torque values are higher than the calibration values).

Calibration can be easily adjusted from outside by tightening of the self-locking ring nut, which causes the compression of the 4 Belleville washers arranged in series.

The device does not go together with:

- the use of tapered roller bearings at output
- prolonged operation under slipping conditions

The following table shows the values of M_{2S} slipping torques depending on the number of revolutions of the ring nut.

Calibration values feature a $\pm 10\%$ tolerance and refer to static conditions.

Under dynamic conditions the values of the slipping torque will change according to the type of overload: the values are higher if the load increase is uniform; the values are lower if sudden load peaks occur.

NOTE: *Slipping occurs when the setting values are exceeded.*

The friction coefficient between the contact surfaces from static becomes dynamic and the transmitted torque is approx. 30% lower.

It is advisable to have a stop first in order to have a restart based on the initial setting value.

It is important to note that the slipping torque is not the same for the whole life of the torque limiter.

It usually decreases in connection with the numbers and the duration of the slipping which because of the surfaces' lapping will increase the efficiency.

For this reason it is advisable to check the calibration of the device at regular intervals, specially during the running-in period.

Should a smaller calibration error be required, it is necessary to test the transmissible torque on the plant.

The device is supplied already calibrated at the torque reported in the catalogue T_{2M} , unless otherwise specified in the order.

4.10 Drehmomentenbegrenzer mit durchgehender Hohlwelle

Die Anwendung eines Drehmoment- Die Anwendung eines Drehmoment- begrenz- zers wird empfohlen, um die Anlage und/ oder das Getriebe gegen ungewünschte und unerwartete Überbe- lastungen zu schützen.

Es handelt sich um eine Vorrichtung mit einer durchgehenden Hohlwelle.

Er ist in dem Getriebe integriert, d.h. der Raumbedarf ist klein. Der Begrenzer wurde für Betrieb in einem Ölbad entworfen. Er ist zuverlässig und verschleißfrei (nur im Falle eines dauerhaften Rutschens entsteht Verschleiß, hier ist das Drehmoment größer als der eingestellte Eichwert).

Die Eichung kann mühelos von aussen durch das Anziehen einer selbstsperrenden Mutter ausgeführt werden, dadurch wird der Druck auf die 4 wechselseitig angeordneten Tellerfedern erhöht.

Die Vorrichtung sieht das folgende nicht vor:

- die Verwendung von Kegelrollenlager am Abtrieb
- Längerer Rutschbetrieb

Die nachstehende Tabelle zeigt die Werte der Rutschmomente M_{2S} abhängig von der Anzahl der Umdrehungen der Mutter. Die Eichwerte weisen $\pm 10\%$ Toleranz auf und beziehen sich auf statische Bedingungen.

Unter dynamischen Bedingungen hat das Rutschmoment verschiedene Werte je nach Art der Überbelastung. Die Werte sind höher, wenn die Belastung gleichmäßig zunimmt; sie sind niedriger im Falle von plötzlichen Belastungsspitzen.

BEMERKUNG: Rutschen tritt auf, wenn die eingestellten Werte überschritten werden. Der Reibungsfaktor zwischen den Berührungsflächen wird dynamisch anstatt statisch und das übertragene Drehmoment sinkt um ca. 30%.

Es ist daher ratsam, vor dem erneuten Anfahren anzuhalten, um die ursprünglichen Drehmomentwerte zu erreichen.

Es ist wichtig zu beachten, dass das Rutschmoment über die gesamte Lebensdauer der Rutschkupplung nicht konstant bleibt, sondern üblicherweise in Verbindung mit längeren Rutschzyklen aufgrund der eingelaufenen Berührungsflächen abnimmt.

Deswegen ist es ratsam, die Eichung der Vorrichtung besonders während der Einlaufzeit zu prüfen.

Falls ein niedrigerer Eichfehler gewünscht ist, sollte das übertragbare Drehmoment auf der Anlage getestet werden.

Wenn die Vorrichtung geliefert wird, ist sie schon auf das im Katalog T_{2M} angegebenen Drehmoment geeicht, ausser wenn es in der Bestellung anders angegebene wird.

4.10 Limitatore di coppia cavo passante

4.10 Torque limiter with through hollow shaft

4.10 Drehmomentbegrenzer mit durchgehender Hohlwelle

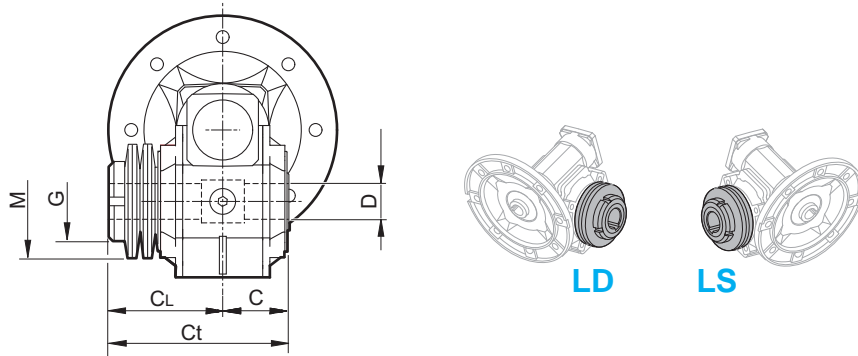

BFK BRK	C	CL	Ct	D (H7)	M	G
63	60	97	157	25	71x40.5x2	M40X1.5
75	60	100	160	28 (30)	90x50.5x2.5	M50X1.5

() A richiesta / On request / Auf Anfrage

Nella versione con limitatore non è prevista la fornitura degli alberi lenti.

Il dispositivo viene consegnato tarato alla coppia riportata a catalogo T2M salvo diversa indicazione espressa in fase di ordinazione.

The version with torque limiter is supplied without output shafts.

The device is supplied already calibrated at the torque reported in the catalogue T2M, unless otherwise specified in the order.

Die Version mit Drehmomentbegrenzer wird ohne Abtriebswellen geliefert.

Wenn die Vorrichtung geliefert wird, ist sie schon auf dem im Katalog T2M angegebenen Drehmoment geeicht, ausser wenn es in der Bestellung anders angegeben wird.

BFK BRK	N°. giri della ghiera di regolazione / N°. revolutions of ring nut Nr. Umdrehungen der Mutter										
	1 1/4	1 1/2	1 3/4	2	2 1/4	2 1/2	2 3/4	3	3 1/4	3 1/2	3 3/4
	M_{2S} [Nm]										
63	—	—	85	95	110	125	137	150	—	—	—
75	—	—	—	—	147	165	177	190	205	220	230

Disposizione delle molle
Washers' arrangement
Lage der Feder

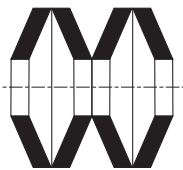

IN SERIE (min. coppia, max. sensibilità)
SERIES (min. torque, max sensitivity)
SERIE (min. Moment, max. Empfindlichkeit)



BFK - BRK

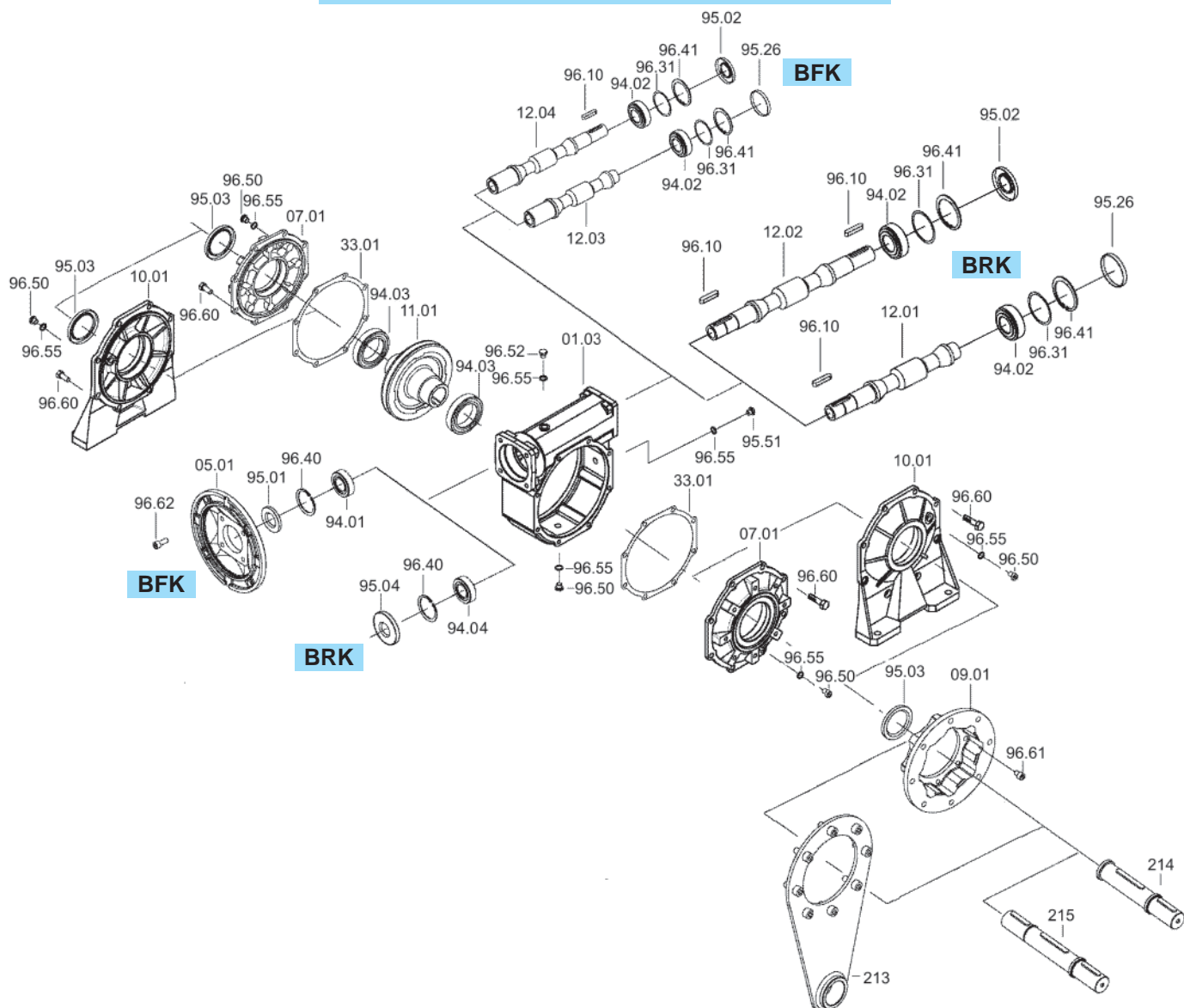

BFK BRK	IEC	Cuscinetti / Bearings / Lager				Anelli di tenuta / Oilseals Öldichtungen				Cappellotto Closed oil seal Geschlossene Öldichtung
		94.01	94.02	94.03	94.04	95.01	95.02	95.03	95.04	
30	56	61804 (20x32x7)	6000 10x26x8	16005 25x47x8	6201 12x32x10	20/32/7	10/26/7	25/40/7	12/32/7	ø 26x7
	63	61804 (20x32x7)				20/32/7				
40	56	6303 (17x47x14)	6201 12x32x10	16006 30x55x9	6303 17x47x14	17/47/7	12/32/7	30/47/7 (A, B, V) 30/45/7 (P)	17/47/7	ø 32x7
	63	6204 (20x47x14)				20/47/7				
	71	6005 (25x47x12)				25/47/7				
50	63	6204 (20x47x14)	6203 17x40x12	6008 40x68x15	6204 20x47x14	20/47/7	17/40/7	40/62/8 (A, B, V) 40/56/8 (P)	20/47/7	ø 40x7
	71	6005 (25x47x12)				25/47/7				
	80	6006 (30x55x13)				30/55/7				
63	71	30305 (25x62x18.25)	30204 20x47x15.25	6008 40x68x15	30305 25x62x18.25	25/62/7	20/47/7	40/62/8	25/62/7	ø 47x7
	80	30206 (30x62x17.25)				30/62/7				
	90	32007 (35x62x18)				35/62/7				
75	71	30206 (30x62x17.25)	30205 25x52x16.25	6010 50x80x16	30305 25x62x18.25	30/62/7	25/52/7	50/72/8	25/62/7	ø 52x7
	80	30206 (30x62x17.25)				30/62/7				
	90	32007 (35x62x18)				35/62/7				
	100/112	32008 (40x68x19)				40/68/10				

BFK - BRK

Limitatore di coppia cavo passante

Torque limiter with through hollow shaft

Drehmomentbegrenzer mit durchgehende Hohlwelle

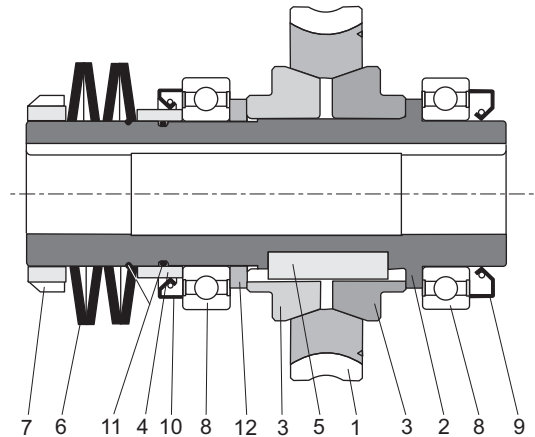

		BFK - BRK	
		63 (LD - LS)	75 (LD - LS)
5	Linguetta / Key / Passfeder	12x8x40A	16x10x40A
8	Cuscinetti / Bearings / Lager	6008 40x68x15	6010 50x80x16
9	Anelli di tenuta / Oilseals	40x62x8	50x72x8
10	Öldichtungen	48x62x8	58x72x8
11	O-rings in gomma Rubber O-rings Gummi-O-ringe	OR 36.27x1.78	OR2187 47.37x1.78